



LED Display
Product Data Sheet
LTS-2306CKD-P

Spec No. :DS30-2013-0036
Effective Date: 01/18/2020
Revision: A

LITE-ON DCC

RELEASE

BNS-OD-FC001/A4

**LED DISPLAY
LTS-2306CKD-P**

LED DISPLAY

LTS-2306CKD-P

<u>Rev</u>	<u>Description</u>	<u>By</u>	<u>Date</u>
01	Preliminary Spec.	Reo Lin	02/19/2013
02	Revised error for P/N in page 1	Reo Lin	03/08/2013
Above data for PD and Customer tracking only			
-	NPPR Received and Upload on System	Reo Lin	07/20/2013
A	Update Packing spec. in page 9	Reo Lin	01/10/2020

LED DISPLAY LTS-2306CKD-P

1. Description

The LTS-2306CKD-P is a 0.28 inch (7.0 mm) digit height single digit SMD display. This device uses AS-AllnGap Hyper Red LED chips (AllnGap epi on GaAs substrate). The display has gray face and white segments.

1.1 Features

- 0.28 inch (7.0 mm) DIGIT HEIGHT
- CONTINUOUS UNIFORM SEGMENTS
- LOW POWER REQUIREMENT
- EXCELLENT CHARACTERS APPEARANCE
- HIGH BRIGHTNESS & HIGH CONTRAST
- WIDE VIEWING ANGLE
- SOLID STATE RELIABILITY
- CATEGORIZED FOR LUMINOUS INTENSITY.
- LEAD-FREE PACKAGE (ACCORDING TO ROHS)

1.2 Device

Part No	Description
AllnGaP Hyper Red	Common Cathode
LTS-2306CKD-P	

LED DISPLAY LTS-2306CKD-P

2. Package Dimensions

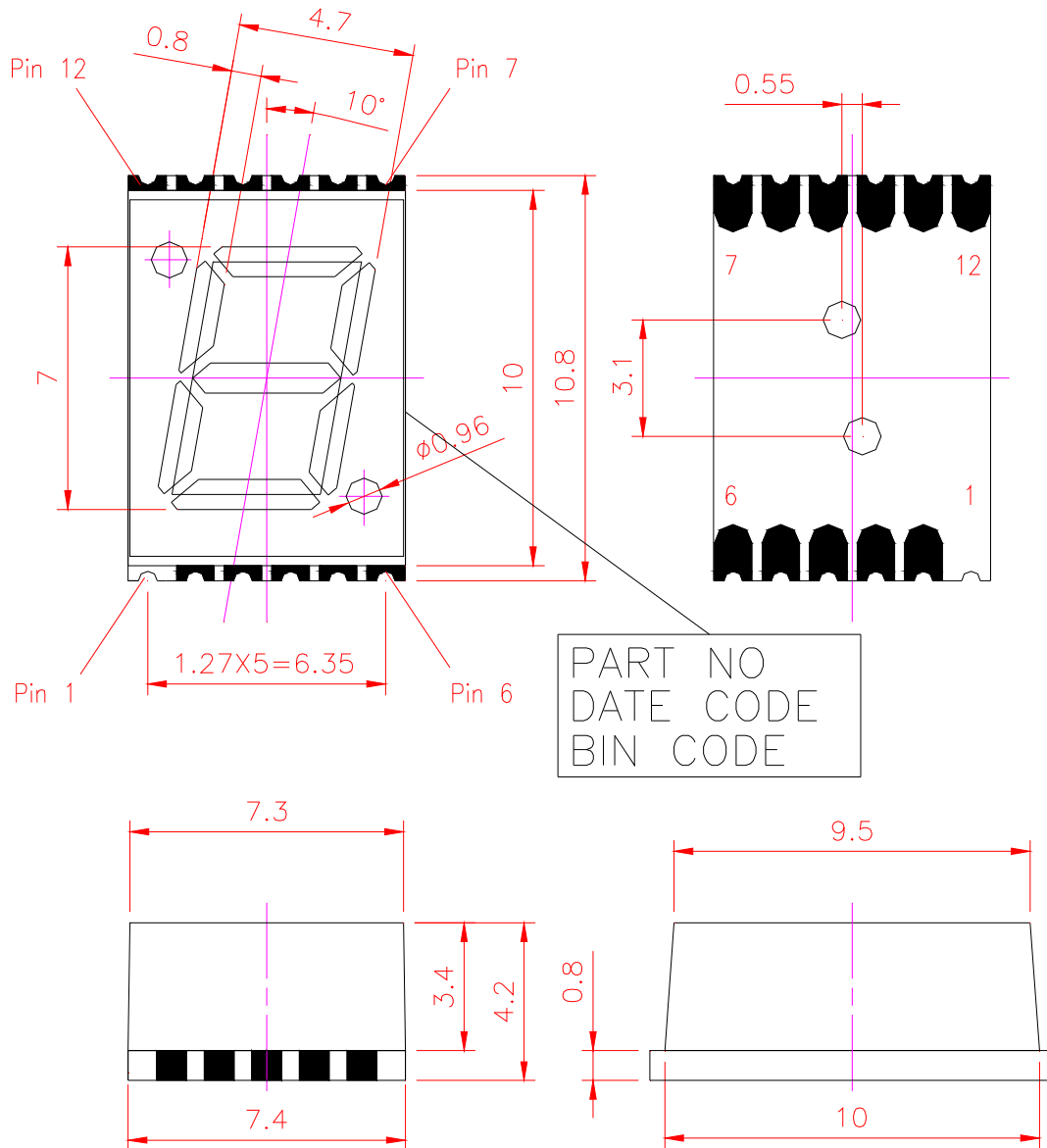

Notes :

1. All dimensions are in millimeters. Tolerances are ± 0.25 mm (0.01") unless otherwise noted
2. Foreign material on segment ≤ 10 mil
3. Ink contamination (surface) ≤ 20 mils
4. Bubble in segment ≤ 10 mil
5. Bending $\leq 1\%$ of reflector length
6. Plastic pin's burr max is 0.1 mm

**LED DISPLAY
LTS-2306CKD-P**

3. Internal Circuit Diagram

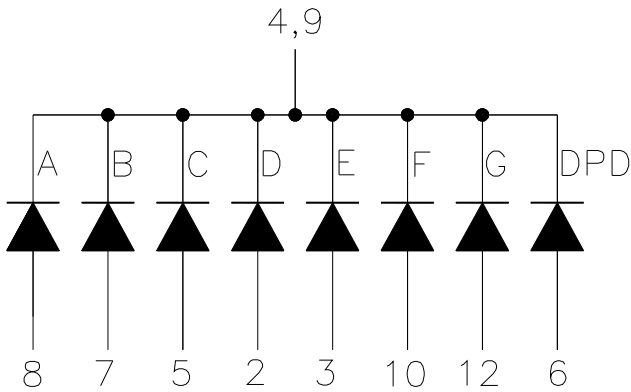
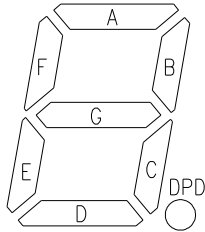

4. Pin Connection

No	Connection
1	NO CONNECTION
2	ANODE D
3	ANODE E
4	COMMON CATHODE
5	ANODE C
6	ANODE DP
7	ANODE B
8	ANODE A
9	COMMON CATHODE
10	ANODE F
11	NO CONNECTION
12	ANODE G

LED DISPLAY LTS-2306CKD-P

5. Rating and Characteristics

5.1. Absolute Maximum Rating at Ta=25°C

Parameter	Maximum Rating	Unit
Power Dissipation Per Segment	70	mW
Peak Forward Current Per Segment (1/10 Duty Cycle, 0.1ms Pulse Width)	90	mA
Continuous Forward Current Per Segment Derating Linear From 25°C Per Segment	25 0.28	mA mA/°C
Operating Temperature Range	-35°C to +105°C	
Storage Temperature Range	-35°C to +105°C	
Iron Soldering Conditions: 1/16 inch Below Seating Plane for 3 Seconds at 260°C		

5.2. Electrical / Optical Characteristics at Ta=25°C

Parameter	Symbol	MIN.	TYP.	MAX.	Unit	Test Condition
Average Luminous Intensity Per Segment	IV	201	650		μcd	IF=1mA
			8250		μcd	IF=10mA
Peak Emission Wavelength	λp		650		nm	IF=20mA
Spectral Line Half-Width	Δλ		20		nm	IF=20mA
Dominant Wavelength	λd		639		nm	IF=20mA
Forward Voltage Per Chip	VF		2.05	2.6	V	IF=20mA
Reverse Current Per Segment ⁽²⁾	IR			100	μA	VR=5V
Luminous Intensity Matching Ratio (Similar Light Area)	IV-m			2:1		IF=1mA

Notes :

- Luminous intensity is measured with a light sensor and filter combination that approximates the CIE (Commission International De L'Eclairage) eye-response curve
- Reverse voltage is only for IR test. It cannot continue to operate at this situation
- Cross talk specification $\leq 2.5\%$

LED DISPLAY LTS-2306CKD-P

5.3. Typical Electrical / Optical Characteristics Curves

(25°C Ambient Temperature Unless Otherwise Noted)

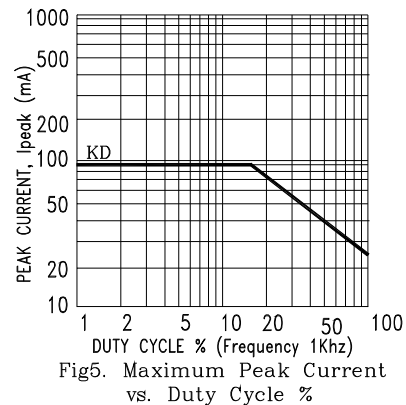
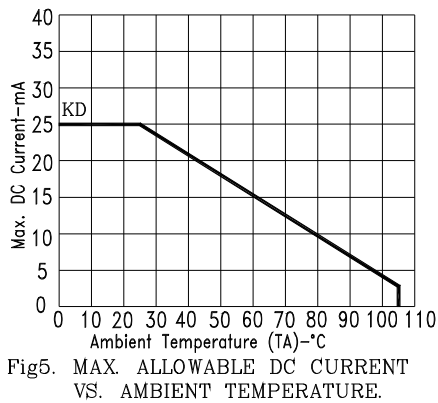
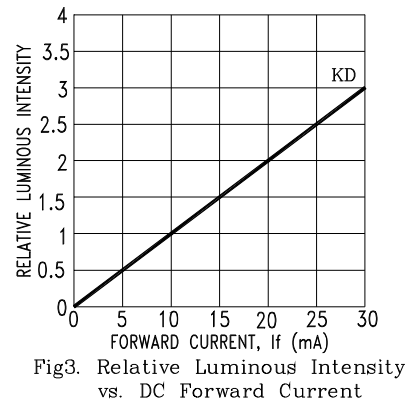
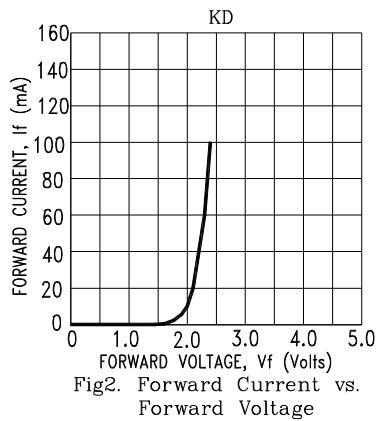
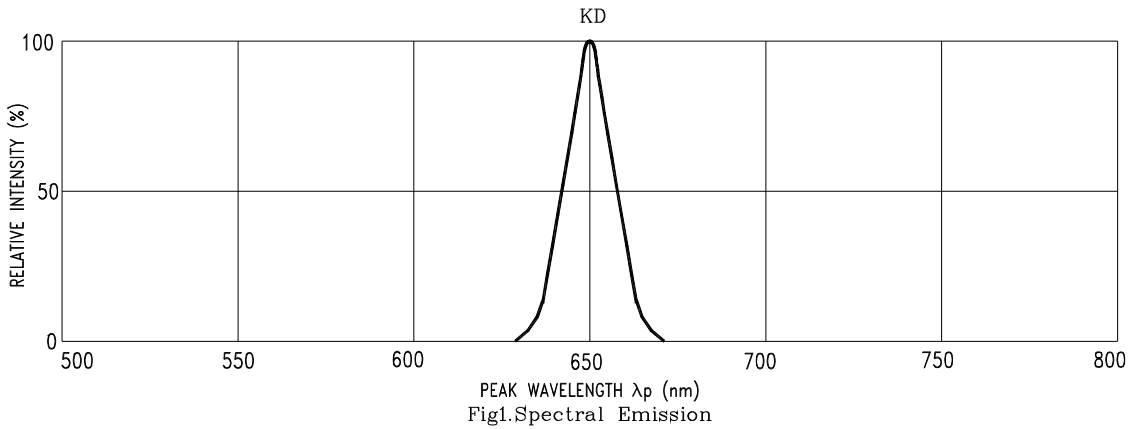

NOTE : KD=AlInGaP HYPER RED

LED DISPLAY LTS-2306CKD-P

6. SMT SOLDERING INSTRUCTION

(Number of reflow process shall be less than 2 times, and cooling process to normal temperature is required between the first and the second soldering process)

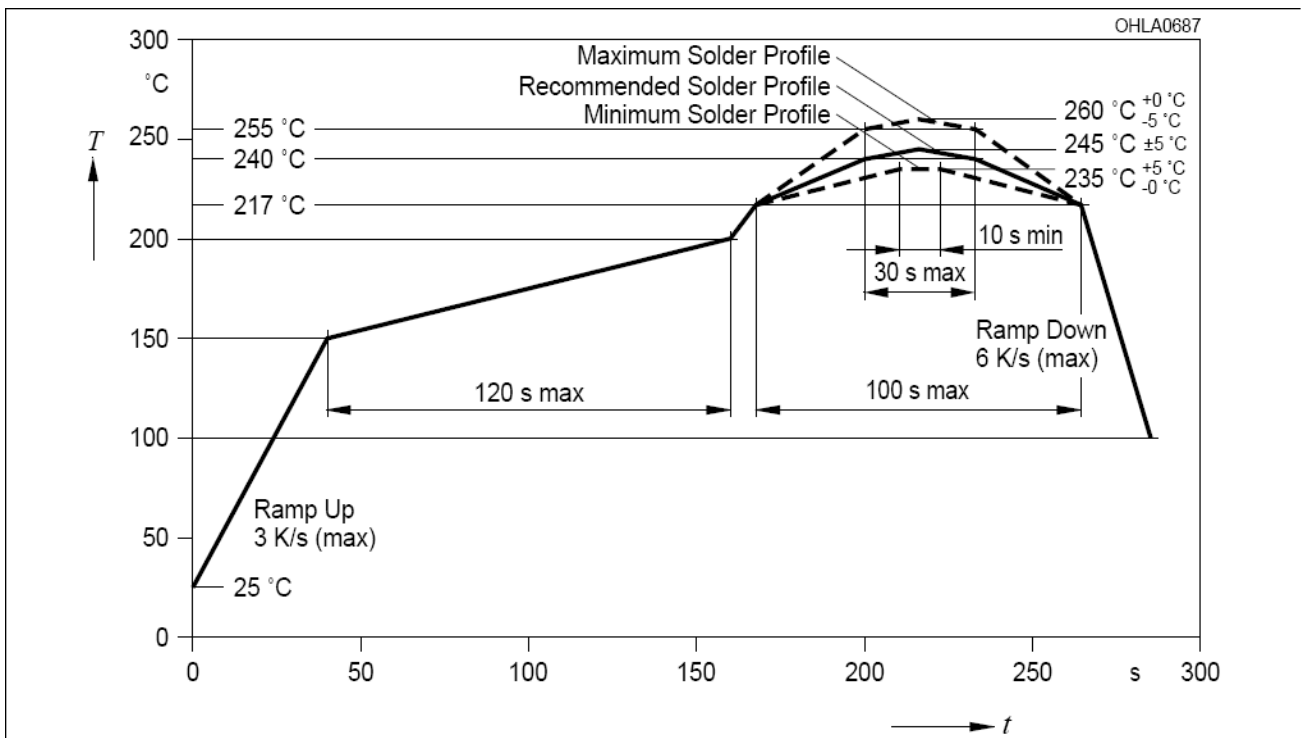

Notes :

1. Recommended soldering condition

Reflow Soldering (Two times only)		Soldering Iron (One time only)	
Pre-heat:	120~150°C.	Temperature	300°C Max.
Pre-heat time:	120sec. Max.	Soldering time	3sec. Max.
Peak temperature:	260°C Max.		
Soldering time:	5sec. Max.		

2. Number of reflow process shall be less than 2 times, and cooling process to normal temperature is required between the first and the second soldering process.

**LED DISPLAY
LTS-2306CKD-P**

7. Recommended Soldering Pattern

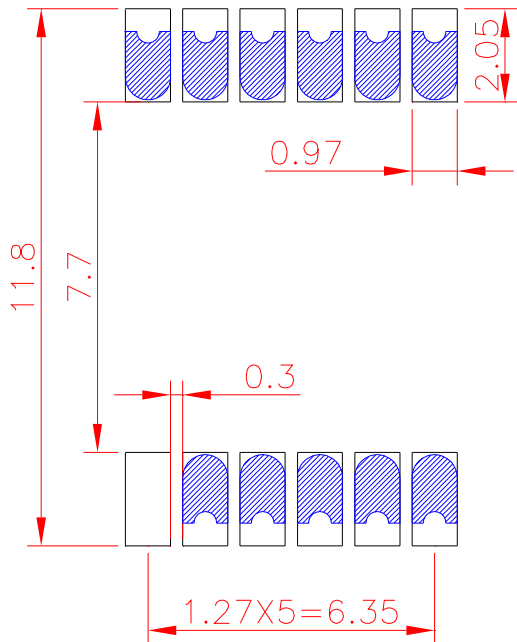

8. Packing Specification

8.1. Packing Reel Dimensions

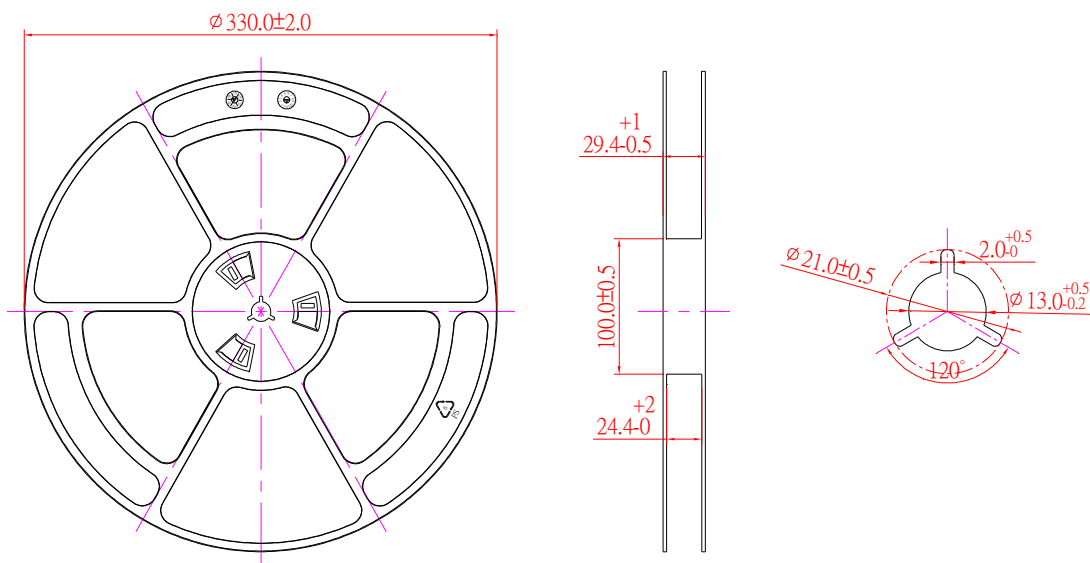

LED DISPLAY LTS-2306CKD-P

8.2. Packing Carrier Dimensions

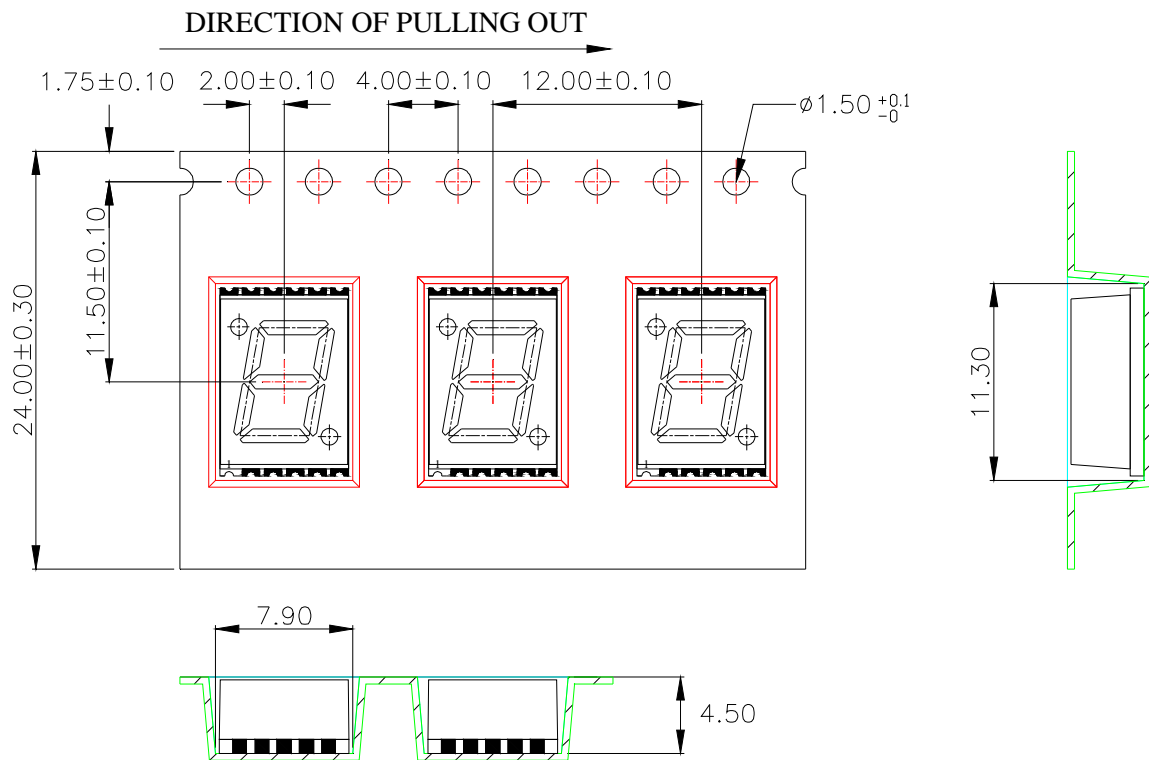

1. 10 sprocket hole pitch cumulative tolerance ± 0.20 .
2. Carrier camber is within 1 mm in 250 mm.
3. Material : Black Conductive Polystyrene Alloy.
4. All dimensions meet EIA-481 requirements.
5. Thickness : 0.40 ± 0.05 mm.
6. Packing length per 22" reel : 38.5 Meters.
7. Component load per 13" reel : 1000 pcs.
8. Minimum packing quantity is 250 pcs for remainders

8.3. Trailer part / Leader part

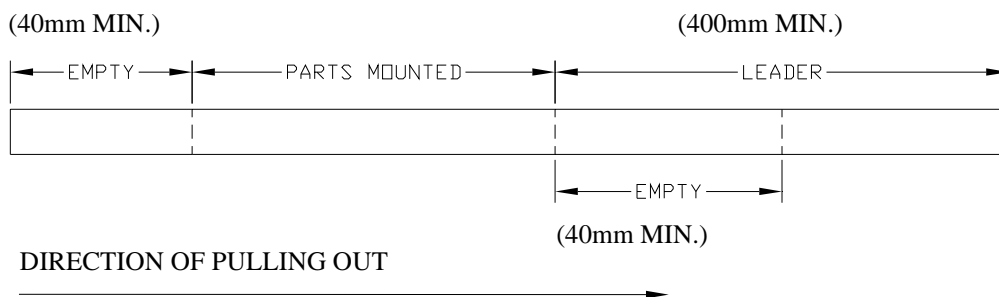

**LED DISPLAY
LTS-2306CKD-P**

9. Moisture Proof Packing

All N/D SMD displays are shipped in moisture proof package. The displays should be stored at 30°C or less and 60% RH or less. Once the package opened, moisture absorption begins.

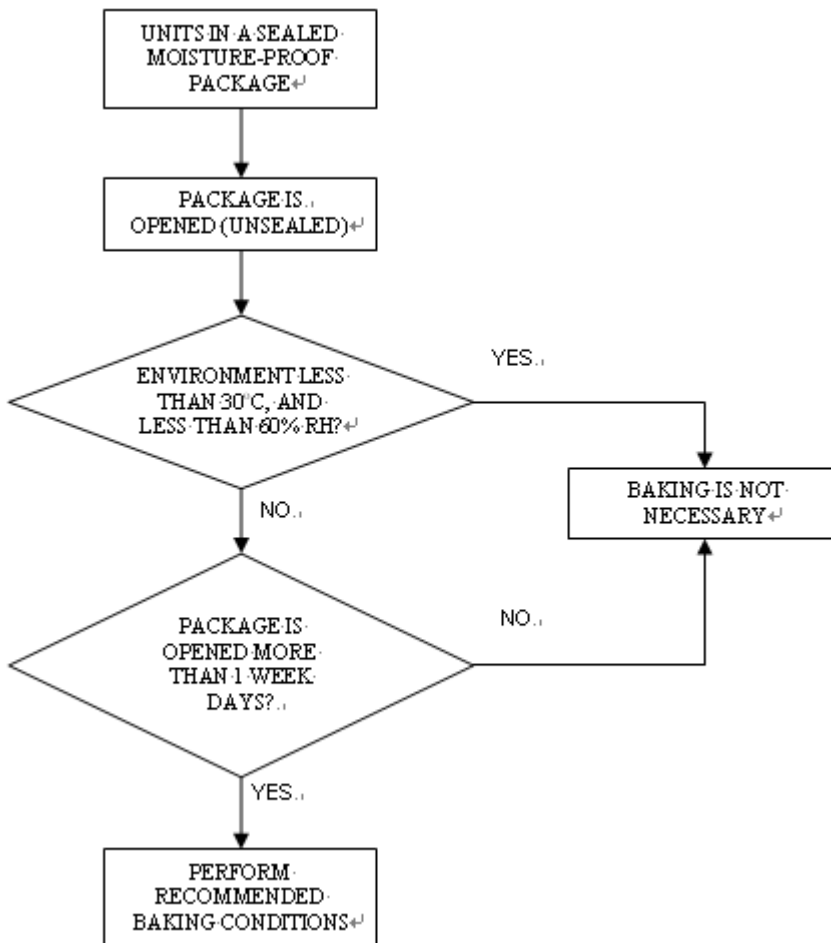

If the parts are not stored in dry conditions, they must be baked before reflow to prevent damage to the parts. Baking should only be done once

Package	Temperature	Time
In Reel	60°C	≥ 48hours
In Bulk	100°C	≥ 4hours
	125°C	≥ 2hours